

CATÁLOGO 2022 Llaves hexagonales de alta calidad

CALIDAD PROFESIONAL

EKLIND Tool Company es el fabricante estadounidense líder mundial en el diseño y fabricación de llaves hexagonales de alta calidad desde 1923.

Todas sus llaves están fabricadas con acero EKLIND Alloy Steel™ de alta resistencia a la torsión y tratadas térmicamente, consiguiendo llaves más fuertes, resistentes y duraderas.

Su acabado anticorrosivo evita que el agua y los agentes contaminantes penetren y dañen la superficie de la llave.

MÁXIMA DUCTILIDAD

La ductilidad es la flexibilidad que siente un usuario cuando aprieta una herramienta. Esta característica de seguridad es muy importante, ya que permite al usuario identificar cuando se está acercando al par máximo de apriete, ayudando a prevenir accidentes y lesiones.

 **MADE IN USA**
Since 1923



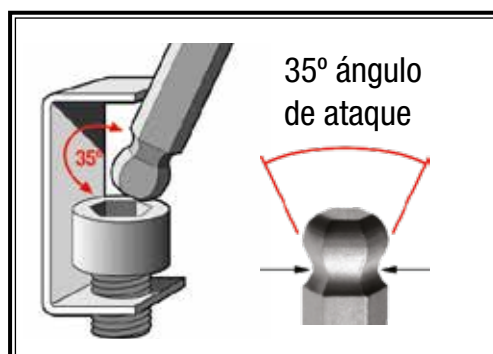

Ángulo de ataque de 35°: fácil y rápido atornillado y desatornillado en áreas de difícil acceso.

Diseño ergonómico: facilita la rotación natural de la mano y muñeca, proporcionando un giro a 360°. Reducción de la fatiga permitiendo al usuario aplicar el par de apriete máximo en las aplicaciones requeridas con el mínimo esfuerzo.

CÓDIGO DE COLORES

MÉTRICO

PULGADAS

TORX® Y PUNTA DE BOLA

GARANTÍA / NORMATIVA INDUSTRIAL ASME Y ANSI

Desde 1923 Eklind diseña y fabrica herramientas de una excelente calidad industrial siguiendo estrictos procesos para cumplir y superar todos los estándares ASME y ANSI.

ASME - AMERICAN SOCIETY OF MECHANICAL ENGINEERS
Sociedad Americana de Ingenieros Mecánicos

ANSI - AMERICAN NATIONAL INSTITUTE
Instituto Nacional Americano de Normalización



Todos los productos EKLIND están garantizados contra defectos de materiales y mano de obra.

LA GAMA MÁS COMPLETA DEL MERCADO

- Punta de bola Ball Hex-L™
- Punta plana Hex-L®
- Punta Torx®-L
- Juegos Ergo-Fold™ Combo
- Llaves en T Power-T™
- Destornilladores de precisión PSD™



ÍNDICE

6. JUEGOS DE LLAVES EN L PUNTA DE BOLA BALL-HEX-L™



7. JUEGOS DE LLAVES EN L PUNTA PLANA HEX-L® y TORX®L



8. JUEGOS DE LLAVES EN T POWER-T™



8. DESTORNILLADORES PROFESIONALES DE PRECISIÓN PSD™



9. LLAVES EN L
BALL-HEX-L™
HEX-L™
TORX®



11. LLAVES EN T POWER-T™



12. JUEGOS DE LLAVES NAVAJA HERGO-FOLD™



13. JUEGOS COMBINADOS



JUEGOS DE LLAVES EN L PUNTA DE BOLA

- 35° Ángulo de ataque
- Acero Eklind Alloy-Steel™



JUEGOS DE LLAVES EN L PUNTA DE BOLA BALL-HEX-L™

Las llaves con brazo corto recortado se ajustan a espacios reducidos donde no hay suficiente cabida libre para una llave estándar.

MÉTRICO



13609



13509



13607



13709



17709

REF.	SERIE	Nº LLAVES	DESCRIPCIÓN	
13609	Largas	9	1.5, 2, 2.5, 3, 4, 5, 6, 8, & 10 mm	1
13509	Stubby	9	1.5, 2, 2.5, 3, 4, 5, 6, 8, & 10 mm	1
13607	Largas	7	1.5, 2, 2.5, 3, 4, 5, & 6 mm	1
13709	Cromadas largas	9	1.5, 2, 2.5, 3, 4, 5, 6, 8, & 10 mm	1
17709	Cromadas extralargas	9	1.5, 2, 2.5, 3, 4, 5, 6, 8, & 10 mm	1

PULGADAS



13212



13213

REF.	SERIE	Nº LLAVES	DESCRIPCIÓN	
13212	Largas	12	.050, 1/16, 5/64, 3/32, 7/64, 1/8, 9/64, 5/32, 3/16, 7/32, 1/4, & 5/16	1
13213	Largas	13	.050, 1/16, 5/64, 3/32, 7/64, 1/8, 9/64, 5/32, 3/16, 7/32, 1/4, 5/16, & 3/8	1

13609



6

TORX® Y PUNTA DE BOLA



10007

REF.	SERIE	Nº LLAVES	DESCRIPCIÓN	
10007	Largas	7	T10, T15, T20, T25, T27, T30, & T40	1

JUEGOS DE LLAVES EN L PUNTA PLANA HEX-L™ Y TORX®

MÉTRICO



10509

10609

REF.	SERIE	Nº LLAVES	DESCRIPCIÓN	
10509	Cortas	9	1.5, 2, 2.5, 3, 4, 5, 6, 8, & 10 mm	1
10609	Largas	9	1.5, 2, 2.5, 3, 4, 5, 6, 8, & 10 mm	1

TORX®



10807

10907

10707

REF.	SERIE	Nº LLAVES	DESCRIPCIÓN	
10807	Cortas	7	T10, T15, T20, T25, T27, T30, & T40	1
10907	Largas	7	T10, T15, T20, T25, T27, T30, & T40	1
10707	Inviolable	7	TR10, TR15, TR20, TR25, TR27, TR30, & TR40	1



10707

7

JUEGOS DE LLAVES EN T POWER-T™

CÓDIGO DE COLORES

MÉTRICO
TORX®

Mango ergonómico fabricado en doble molde que proporciona la máxima comodidad y resistencia al deslizamiento para una mayor seguridad.

Disponibles en una resistente bolsa de vinilo transparente, que puede colocarse de forma compacta en una caja de herramientas y es fácil de colgar en el taller. Las bolsas de vinilo están codificadas por colores, lo que las hace identificables al instante.

68991



REF.	PUNTA	LONG.	Nº LLAVES	DESCRIPCIÓN	
64808	Bola	230 mm	8	2, 2.5, 3, 4, 5, 6, 8, & 10 mm	1
64908	Hexagonal	230 mm	8	2, 2.5, 3, 4, 5, 6, 8, & 10 mm	1

REF.	PUNTA	LONG.	Nº LLAVES	DESCRIPCIÓN	
68991	Torx®	230 mm	11	T6, T8, T10, T15, T20, T25, T27, T30, T40, T45, & T50	1

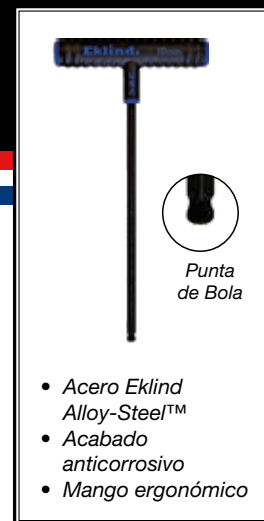

DESTORNILLADORES PROFESIONALES DE PRECISIÓN PSD™

Los destornilladores de precisión profesionales Eklind PSD™ se fabrican con los mismos estándares de alta calidad que han convertido a Eklind Tool Company en el fabricante líder de productos de llaves hexagonales de fabricación estadounidense.

Un mango ergonómico más grande y cónico está diseñado para ofrecer comodidad y control a los profesionales. El sombrerete giratorio mantiene el control de la punta de los dedos.

Disponibles en una resistente bolsa de vinilo transparente, que puede colocarse de forma compacta en una caja de herramientas y es fácil de colgar en el taller.

92400



8

REF.	PUNTA	Nº LLAVES	DESCRIPCIÓN	
92400	Hexagonal	8	0.7, 0.9, 1.3, 1.5, 2, 2.5, 3, & 4 mm	1



MÉTRICO

LLAVES EN L

- 35° Ángulo de ataque
- Acero Eklind Alloy-Steel™
- Código de colores

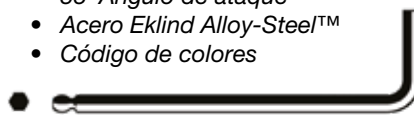

35° ángulo de ataque

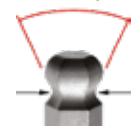





LLAVES LARGAS EN L PUNTA-BOLA MÉTRICA CON CÓDIGO DE BARRAS BALL-HEX-L™

MÉTRICO

REF.				
14402	1,3 mm	72 mm	14 mm	5
14403	1,5 mm	77 mm	14 mm	5
14404	2 mm	81 mm	16 mm	5
14405	2,5 mm	88 mm	18 mm	5
14406	3 mm	99 mm	19 mm	5
14407	3,5 mm	102 mm	21 mm	5
14408	4 mm	104 mm	24 mm	5
14409	4,5 mm	110 mm	25 mm	5
14410	5 mm	116 mm	27 mm	5
14412	6 mm	138 mm	31 mm	5
14414	7 mm	157 mm	35 mm	5
14416	8 mm	157 mm	35 mm	5
14418	9 mm	167 mm	39 mm	5
14420	10 mm	167 mm	39 mm	5
14422	11 mm	175 mm	38 mm	5
14424	12 mm	209 mm	44 mm	5
14428	14 mm	232 mm	55 mm	5
14434	17 mm	246 mm	61 mm	5

* LLAVES CORTAS EN L PUNTA PLANA PULGADAS HEX-L®

REF.				
15128	7/16"	121 mm	38 mm	5
15132	1/2"	133 mm	41 mm	5
15136	9/16"	146 mm	44 mm	5
15140	5/8"	159 mm	48 mm	5
15148	3/4"	184 mm	54 mm	1
15156	7/8"	210 mm	60 mm	1
15164	1"	235 mm	67 mm	1
15166	1 1/8"	260 mm	70 mm	1
15168	1 1/4"	308 mm	122 mm	1
15172	1 1/2"	337 mm	89 mm	1
15176	1 3/4"	387 mm	102 mm	1
15180	2"	438 mm	114 mm	1

* Consultar plazo de entrega

LLAVES CORTAS HEXAGONALES MÉTRICAS HEX-L®

MÉTRICO





REF.				
15500	0.7 mm	31 mm	6 mm	25
15501	0.9 mm	31 mm	9 mm	25
15502	1.3 mm	41 mm	13 mm	25
15503	1.5 mm	44 mm	13 mm	25
15504	2.0 mm	49 mm	15 mm	25
15505	2.5 mm	55 mm	18 mm	25
15506	3.0 mm	61 mm	19 mm	25
15507	3.5 mm	65 mm	21 mm	5
15508	4.0 mm	68 mm	24 mm	25
15509	4.5 mm	73 mm	25 mm	5
15510	5.0 mm	78 mm	27 mm	25
15511	5.5 mm	83 mm	29 mm	5
15512	6.0 mm	88 mm	31 mm	10
15514	7.0 mm	93 mm	35 mm	5
15516	8.0 mm	98 mm	35 mm	5
15518	9.0 mm	103 mm	39 mm	5
15520	10.0 mm	109 mm	39 mm	5
15522	11.0 mm	121 mm	38 mm	5
15524	12.0 mm	122 mm	44 mm	5
15528	14.0 mm	136 mm	55 mm	5

* LLAVES CORTAS EN L PUNTA PLANA PULGADAS HEX-L®

PULGADAS

REF.				
15101	.028"	31 mm	6 mm	25
15102	.035"	31 mm	9 mm	25
15103	.050"	42 mm	13 mm	25
15104	1/16"	44 mm	14 mm	25
15105	5/64"	49 mm	15 mm	25
15106	3/32"	51 mm	17 mm	25
15107	7/64"	54 mm	18 mm	25
15108	1/8"	57 mm	19 mm	25
15109	9/64"	60 mm	20 mm	25
15110	5/32"	64 mm	21 mm	25
15112	3/16"	70 mm	24 mm	25
15114	7/32"	76 mm	26 mm	10
15116	1/4"	83 mm	28 mm	10
15120	5/16"	95 mm	32 mm	5
15124	3/8"	108 mm	35 mm	5

LLAVES EN L

REF.				
15534	17.0 mm	156 mm	61 mm	1
15538	19.0 mm	176 mm	69 mm	1
15544	22.0 mm	195 mm	78 mm	1
15548	24.0 mm	218 mm	88 mm	1
15551	27.0 mm	244 mm	98 mm	1
15556	32.0 mm	308 mm	122 mm	1
15560	36.0 mm	346 mm	136 mm	1

* LLAVES LARGAS HEXAGONALES MÉTRICAS HEX-L®





MÉTRICO

REF.				
15600	0.7 mm	66 mm	5 mm	25
15601	0.9 mm	68 mm	9 mm	25
15602	1.3 mm	74 mm	14 mm	25
15603	1.5 mm	77 mm	14 mm	25
15604	2.0 mm	81 mm	16 mm	25
15605	2.5 mm	88 mm	18 mm	25
15606	3.0 mm	99 mm	19 mm	25
15607	3.5 mm	101 mm	21 mm	5
15608	4.0 mm	104 mm	24 mm	25
15609	4.5 mm	110 mm	25 mm	5
15610	5.0 mm	116 mm	27 mm	25
15611	5.5 mm	127 mm	29 mm	5
15612	6.0 mm	138 mm	31 mm	10
15614	7.0 mm	157 mm	35 mm	5
15616	8.0 mm	157 mm	35 mm	5
15618	9.0 mm	167 mm	39 mm	5
15620	10.0 mm	167 mm	39 mm	5
15622	11.0 mm	191 mm	38 mm	5
15624	12.0 mm	209 mm	44 mm	5
15628	14.0 mm	232 mm	55 mm	5
15634	17.0 mm	246 mm	61 mm	1
15638	19.0 mm	276 mm	69 mm	1
15644	22.0 mm	330 mm	78 mm	1
15648	24.0 mm	362 mm	88 mm	1
15651	27.0 mm	413 mm	98 mm	1
15656	32.0 mm	503 mm	122 mm	1
15660	36.0 mm	514 mm	136 mm	1

* Consultar plazo de entrega

* LLAVES CORTAS TORX®





TORX®

REF.				
15805	T5	39 mm	16 mm	5
15806	T6	40 mm	16 mm	5
15807	T7	44 mm	16 mm	5
15808	T8	46 mm	16 mm	5
15809	T9	49 mm	16 mm	5
15810	T10	51 mm	17 mm	10
15815	T15	54 mm	18 mm	10
15820	T20	57 mm	19 mm	10
15825	T25	60 mm	20 mm	10
15827	T27	64 mm	22 mm	10
15830	T30	70 mm	24 mm	10
15840	T40	76 mm	26 mm	10
15845	T45	83 mm	29 mm	5
15850	T50	94 mm	32 mm	5
15855	T55	108 mm	35 mm	5
15860	T60	121 mm	38 mm	5

* Consultar plazo de entrega

* LLAVES LARGAS TORX®

TORX®

REF.				
15905	T5	72 mm	14 mm	5
15906	T6	75 mm	16 mm	5
15907	T7	77 mm	16 mm	5
15908	T8	80 mm	16 mm	5
15909	T9	83 mm	16 mm	5
15910	T10	86 mm	17 mm	10
15915	T15	91 mm	18 mm	10
15920	T20	96 mm	19 mm	10
15925	T25	100 mm	20 mm	10
15927	T27	106 mm	22 mm	10
15930	T30	114 mm	24 mm	10
15940	T40	124 mm	26 mm	10
15945	T45	133 mm	29 mm	5
15950	T50	152 mm	32 mm	5
15955	T55	171 mm	35 mm	5
15960	T60	191 mm	38 mm	5

* Consultar plazo de entrega

LLAVES EN T





- Mango ergonómico
- Acero Eklind Alloy-Steel™
- Código de colores
- Punta de Bola



LLAVES EN T LARGAS PUNTA DE BOLA MÉTRICAS POWER-T™

MÉTRICO







REF.		 mm	 mm	
64820	2.0	76 mm	229 mm	4
64825	2.5	76 mm	229 mm	4
64830	3.0	76 mm	229 mm	4
64840	4.0	76 mm	229 mm	4
64850	5.0	102 mm	229 mm	4
64860	6.0	102 mm	229 mm	4
64870	7.0	102 mm	229 mm	2
64880	8.0	127 mm	229 mm	2
64885	9.0	127 mm	229 mm	2
64890	10.0	127 mm	229 mm	2

* LLAVES EN T TORX® POWER-T™

TORX®







REF.		 mm	 mm	
68906	T6	76 mm	229 mm	4
68907	T7	76 mm	229 mm	4
68908	T8	76 mm	229 mm	4
68909	T9	76 mm	229 mm	4
68910	T0	76 mm	229 mm	4
68915	T15	76 mm	229 mm	4
68920	T20	76 mm	229 mm	4
68925	T25	76 mm	229 mm	4
68927	T27	102 mm	229 mm	4
68930	T30	102 mm	229 mm	4
68940	T40	102 mm	229 mm	4
68945	T45	127 mm	229 mm	2
68950	T50	127 mm	229 mm	2

* Consultar plazo de entrega

LLAVES EN T CORTAS HEXAGONALES POWER-T™

MÉTRICO



REF.		 mm	 mm	
64620	2.0	76 mm	152 mm	4
64625	2.5	76 mm	152 mm	4
64630	3.0	76 mm	152 mm	4
64640	4.0	76 mm	152 mm	4
64650	5.0	102 mm	152 mm	4
64660	6.0	102 mm	152 mm	4
64670	7.0	102 mm	152 mm	2
64680	8.0	127 mm	152 mm	2
64685	9.0	127 mm	152 mm	2
64690	10.0	127 mm	152 mm	2

JUEGOS DE LLAVES NAVAJA HERGO-FOLD™

Mango especial ergonómico que ofrece un tacto suave, máxima comodidad y resistencia al deslizamiento.

Su carcasa especial fabricada en plástico duro proporciona una gran resistencia a los golpes.

Mango ergonómico



MÉTRICO



REF.	Nº LLAVES	DESCRIPCIÓN	
25161	6	3, 4, 5, 6, 8, & 10 mm	1
25171	7	1.5, 2, 2.5, 3, 4, 5, & 6 mm	1
25172	7	2, 2.5, 3, 4, 5, 6, & 8 mm	1

TORX®



REF.	Nº LLAVES	DESCRIPCIÓN	
25581	8	T8, T10, T15, T20, T25, T27, T30, & T40	1
25582	8	T6, T7, T8, T9, T10, T15, T20, & T25	1
25570 (Inviolable)	7	TR10, TR15, TR20, TR25, TR27, TR30, & TR40	1

JUEGO DE LLAVES NAVAJA HERGO-FOLD™

Especial bicicletas



REF.	Nº LLAVES	DESCRIPCIÓN	
25651	5	4, 5, 6, F3/16, & P#1	1

JUEGOS COMBINADOS

Los conjuntos combinados EKLIND son una excelente opción cuando se necesitan llaves hexagonales métricas y en pulgadas. Estos juegos ofrecen una gran utilidad y comodidad puesto que incluyen los tamaños más utilizados en métrico, pulgada; así como estilos de puntas: punta de bola, hexagonal y Torx®.

Las herramientas TORX® son compatibles con todas las fijaciones TORX, TORX PLUS y "estrella".

CÓDIGO DE COLORES

MÉTRICO

TORX®

PULGADAS

JUEGOS COMBINADOS DE LLAVES EN L PUNTA DE BOLA BALL-HEX-L™

13222 Pack 13213 (13 llaves) + 13609 (9 llaves)



REF. SET	REF.	Nº LLAVES	DESCRIPCIÓN	
13222	13609	9	1.5, 2, 2.5, 3, 4, 5, 6, 8, & 10 mm	1
	13213	13	.050, 1/16, 5/64, 3/32, 7/64, 1/8, 9/64, 5/32, 3/16, 7/32, 1/4, 5/16, & 3/8	1

JUEGOS COMBINADOS DE LLAVES NAVAJA HERGO-FOLD™

25024 Pack 25171 (7 llaves) + 25581 (8 llaves) + 25911 (9 llaves)



25024

REF. SET	REF.	Nº LLAVES	DESCRIPCIÓN	
25024	25171	7	1.5, 2, 2.5, 3, 4, 5, & 6 mm	1
	25581	8	T8, T10, T15, T20, T25, T27, T30, & T40	1
	25911	9	5/64, 3/32, 7/64, 1/8, 9/64, 5/32, 3/16, 7/32, & 1/4	1

25030 Pack 25171 (7 llaves) + 25461 (6 llaves) + 25581 (8 llaves) + 25911 (9 llaves)



25030

REF. SET	REF.	Nº LLAVES	DESCRIPCIÓN	
25030	25171	7	1.5, 2, 2.5, 3, 4, 5, & 6 mm	1
	25461	6	T15, Awl, F1/8, F3/16, F1/4, & P#1	1
	25581	8	T8, T10, T15, T20, T25, T27, T30, & T40	1
	25911	9	5/64, 3/32, 7/64, 1/8, 9/64, 5/32, 3/16, 7/32, & 1/4	1

JUEGOS COMBINADOS DE LLAVES NAVAJA Y JUEGOS DE LLAVES HERGO-FOLD™

29016 Pack 13609 (9 llaves) + 25171 (7 llaves)



29016

REF. SET	REF.	Nº LLAVES	DESCRIPCIÓN	
29016	13609	9	1.5, 2, 2.5, 3, 4, 5, 6, 8, & 10 mm	1
	25171	7	1.5, 2, 2.5, 3, 4, 5, & 6 mm	1

29022 Pack 13213 (13 llaves) + 25911 (9 llaves)



29022

REF. SET	REF.	Nº LLAVES	DESCRIPCIÓN	
29022	13213	13	.050, 1/16, 5/64, 3/32, 7/64, 1/8, 9/64, 5/32, 3/16, 7/32, 1/4, 5/16, & 3/8	1
	25911	9	5/64, 3/32, 7/64, 1/8, 9/64, 5/32, 3/16, 7/32, & 1/4	1

Eklind®



Distribuidor exclusivo para España, Francia y Portugal

Pol. Akarregi, parc. 7-A, local 2
20120 Hernani (Gipuzkoa)
Tel.: (+34) 943 100 311
Email: info.fegemu@fegemu.com
www.fegemu.com

